

Product Catalogue

FAN Series Brochure





About Miwind

Foshan Mifeng Electrical Equipment Co., Ltd. is located in Foshan city, Guangdong. We have a R & D and sales team composed of industry elites, continuous technological innovation and product iteration. Since its inception, the company has always insisted on taking the road of brand development, and actively create its own brand "MIWIND", it has a large experience designing and producing air curtains, centrifugal fans and other special OEM equipment. and through the national CCC, ISO9001, CE, CB, ROHS, and INMETRO and other international safety certificates at the same time. Meanwhile we export our products to more than 45 countries world.

Company Culture

Company mission:

To pursue the material and spiritual well-being of all employees while creating a greener, better life through industry-leading technology, customer-centric service, and the provision of healthy, comfortable air environments.

Company Vision:

To become the global leader in human habitat air environment solutions.

Company values:

Integrity, Altruism, Perseverance, Efficiency, Innovation, Unity.

Development History

<p>2014 Brand creation of MIWIND</p> 	<p>2015 Guangzhou Mifeng Electrical Equipment Company was established</p> 	<p>2016 Into the production line, high standard, high demand for production</p> 	<p>2017 The factory has passed ISO9001 quality management system and the products have passed CCC certification.</p> 	<p>2018 MIWIND Foshan Mifeng production head quarters was established. Set up sales team.</p> 
<p>2019 Products through the SGS, CE, CB, ROHS certification, etc.</p> 	<p>2020 The company's layout of omnichannel marketing online ERP production management system, systematized production.</p> 	<p>2021 We have obtained several corporate certificates such as Certificate of High & New Technological Enterprise</p> 	<p>2022 The factory area has been expanded to 20,000 square meters with a total of 8 automatic assembly lines to meet the demand for bulk production</p> 	<p>2023 Building a new factory in Guangdong-Hong Kong-Macao Greater Bay Area, covering an area of 50,000m².</p> 

PM2.5 HEATING RECOVERY

Remark: All models with standard control, other controller for optional.



Energy Saving

Copper motor with high quality Ball bearing Low noise with stable air volume



Filter

High quantity heating recovery filter Effectively remove most harmful substances and odors in the air.



Thin unit design

Casing thinner to 20CM Saving more space



Easy maintenance

Maintain design Easy for checking motor and replace filter

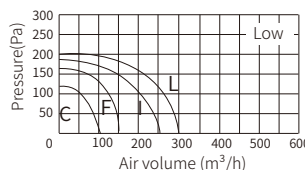
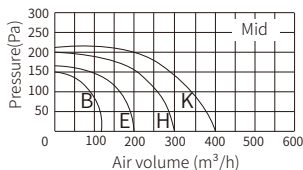
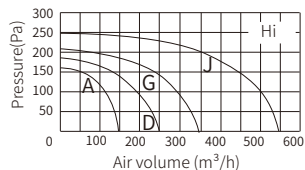

Model	Hi	Mid	Low
MFQR-150	A	B	C
MFQR-250	D	E	F
MFQR-350	G	H	I
MFQR-500	J	K	L

Model	Volt/Hz (V~/Hz)	Speed	Power (W)	Air volume (m³/h)	Pressure (Pa)	Noise (dB)	Heat Exchange efficiency		Enthalpy exchange efficiency		G.W./N.W (kg)	Diameter (φmm)
							Cold(%)	Heat(%)	Cold(%)	Heat(%)		
MFQR-150	220/50	Hi	100	150	170	37	64	78	65	69	27.1/23.4	φ98
		Mid	87	120	150	36	66	79	64	72		
		Low	78	100	130	35	65	79	64	73		
MFQR-250	220/50	Hi	145	250	180	41	63	77	63	69	29.8/26.1	φ145
		Mid	122	200	170	40	66	80	64	68		
		Low	96	150	160	39	65	81	64	68		
MFQR-350	220/50	Hi	160	350	230	41	63	77	63	69	30.4/26.6	φ145
		Mid	150	300	200	40	66	80	64	68		
		Low	140	250	175	39	65	81	64	68		
MFQR-500	220/50	Hi	246	550	250	42	62	70	62	66	31.1/25.1	φ195
		Mid	227	400	220	41	61	71	63	67		
		Low	195	300	200	40	60	71	63	68		

COMMERCIAL HEATING RECOVERY

Remark: 220V models with Switch. Other controller for optional.

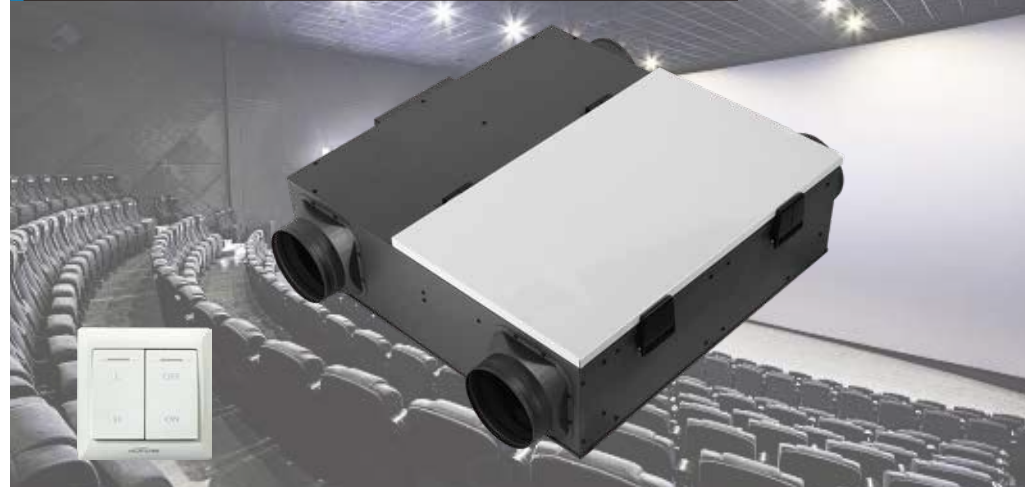

Energy Saving

Copper motor with high quality Ball bearing Low noise with stable air volume



Filter

High quantity heating recovery filter Effectively remove most harmful substances and odors in the air.



Thin unit design

Casing thinner to 20CM Saving more space



Easy maintenance

Maintain design Easy for checking motor and replace filter

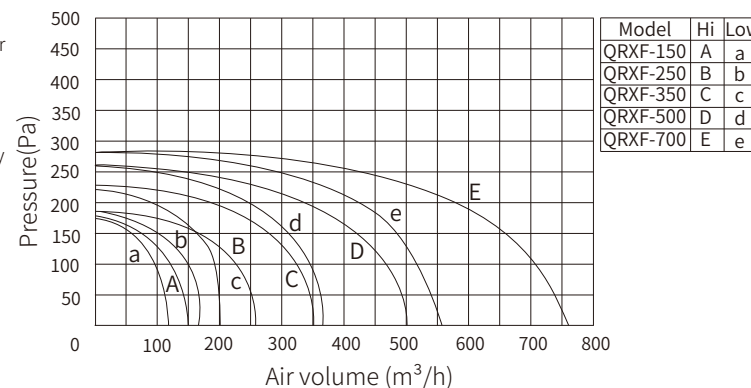

Model	Volt/Hz (V~/Hz)	Speed	Power (W)	Air volume (m³/h)	Pressure (Pa)	Heat Exchange Efficiency		Enthalpy Exchange Efficiency		Noise (dB)	N.W (kg)
						Cold(%)	Heat(%)	Cold(%)	Heat(%)		
QRXF-150	220/50	Hi/Low	100/87	150/120	170/151	64/66	72/73	65/66	68/70	35/32	28.0
QRXF-250	220/50	Hi/Low	145/122	250/180	185/167	62/65	73/75	62/64	67/64	37/35	29.4
QRXF-350	220/50	Hi/Low	155/146	350/280	230/197	62/64	73/74	62/64	68/70	38/36	29.4
QRXF-500	220/50	Hi/Low	246/227	500/380	255/246	64/67	71/73	63/65	67/71	40/38	32.8
QRXF-700	220/50	Hi/Low	293/274	750/580	265/251	61/63	69/70	64/66	68/69	42/40	32.8

COMMERCIAL HEATING RECOVERY



- Energy Saving**
Copper motor with high quality Ball bearing
Low noise with stable air volume
- Filter**
High quantity heating recovery filter
Effectively remove most harmful substances and odors in the air.
- Thin unit design**
Casing thinner to 20CM Saving more space
- Easy maintenance**
Maintain design
Easy for checking motor and replace filter

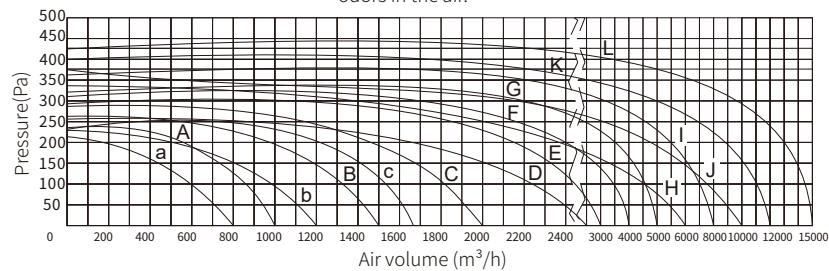

Model	Hi	Low
QRXF-1000	A	a
QRXF-1500	B	b
QRXF-2000	C	c
QRXF-2500	D	/
QRXF-3000	E	/
QRXF-4000	F	/
QRXF-5000	G	/
QRXF-6000	H	/
QRXF-8000	I	/
QRXF-10000	J	/
QRXF-12000	K	/
QRXF-15000	L	/

Model	Volt/Hz (V~/Hz)	Speed	Power (W)	Air volume (m³/h)	Pressure (Pa)	Heat Exchange Efficiency Cold(%)Heat(%)	Enthalpy Exchange Efficiency Cold(%) Heat(%)	Noise (dB)	N.W (kg)		
QRXF-1000	220/50	Hi/Low	600/500	1000/800	245/210	64/67	67/71	62/65	66/69	47/45	60.0
QRXF-1500	220/50	Hi/Low	1100/900	1500/1200	265/242	62/64	68/70	65/68	64/67	50/47	67.0
QRXF-2000	220/50	Hi/Low	1500/1200	2000/1680	270/243	63/66	66/73	63/65	68/71	51/49	74.0
QRXF-2500	380/50	/	1600	2500	260	64	69	64	67	52	100
QRXF-3000	380/50	/	2000	3000	275	67	68	61	65	54	115
QRXF-4000	380/50	/	2200	4000	305	63	74	60	68	55	142
QRXF-5000	380/50	/	3000	5000	320	65	71	65	64	57	155
QRXF-6000	380/50	/	3500	6000	345	64	75	64	68	60	176
QRXF-8000	380/50	/	4500	8000	370	68	76	63	69	62	262
QRXF-10000	380/50	/	6000	10000	385	70	72	63	70	65	320
QRXF-12000	380/50	/	8000	12000	400	72	73	68	71	67	386
QRXF-15000	380/50	/	10000	15000	430	70	69	67	69	69	420

AIR CABINET FAN SERIES



- Energy Saving**
Copper motor with high quality Ball bearing Low noise with stable air volume
- Static Pressure**
Optimize motor and air duct
Static pressure
- Flexible adjustment**
Different application
Air volume from 2000 to 25000 m³/h
- Easy maintenance**
Maintain design
Easy for checking motor and replace filter

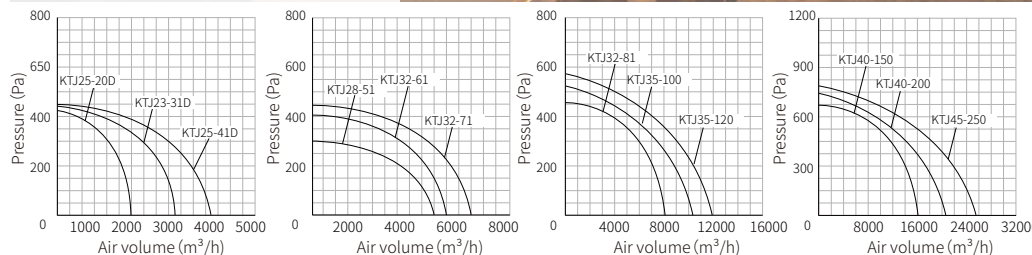

Model	Volt/Hz (V~/Hz)	Power (W)	Air volume (m³/h)	Pressure (Pa)	Speed (rpm)	Noise (dB)	G.W (kg)
KTJ25-20(D)	220/50	780	2000	430	1340	55	28.4
KTJ25-26(D)	220/50	805	2600	410	1340	56	28.4
KTJ23-31(D)	220/50	1150	3100	440	1340	61	36.0
KTJ25-41(D)	220/50	1150	4100	460	1340	65	36.0
KTJ25-20	380/50	780	2000	430	1340	55	28.4
KTJ25-26	380/50	805	2600	410	1340	56	28.4
KTJ23-31	380/50	1150	3100	440	1340	61	36.0
KTJ25-41	380/50	1150	4100	460	1340	65	36.0
KTJ28-51	380/50	1050	5100	400	940	67	55.8
KTJ32-61	380/50	1500	6100	410	940	68	55.8
KTJ32-71	380/50	1955	7100	440	940	67	62.6
KTJ32-81	380/50	2020	8100	461	940	69	68.4
KTJ35-100	380/50	2530	10000	551	940	70	84.0
KTJ35-120	380/50	3680	12000	591	940	71	87.8
KTJ40-150	380/50	4140	15000	700	940	75	115.0
KTJ40-200	380/50	6210	20000	725	940	77	126.8
KTJ45-250	380/50	7856	25000	740	940	79	128.2

PURIFIED DUCT FAN



Energy Saving
Copper motor with high quality Ball bearing Low noise with stable air volume



Filter System
With high quantity filter Stop 90% Harmful substances and odors.



Flexible adjustment
For different applications Combine with other 2 or 3 head duct



Thin unit design
Optimal design, thin body Saving more space

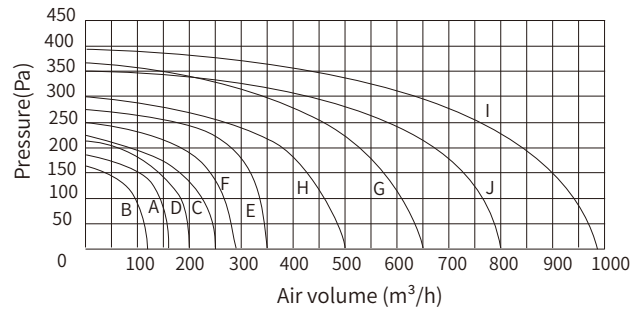

Model	Hi	Low
DPT10-35J	A	B
DPT15-40J	C	D
DPT15-45J	E	F
DPT20-55J	G	H
DPT20-56J	I	J

Model	Volt/Hz (V~/Hz)	Speed	Power (W)	Air volume (m³/h)	Pressure (Pa)	Noise (dB)	G.W/N.W (kg)	Diameter (φmm)
DPT10-35J	220/50	Hi/Low	52/30	160/120	192/170	24/21	8.6/7.2	φ95
DPT15-40J	220/50	Hi/Low	60/50	250/200	240/220	31/25	10.3/8.7	φ147
DPT15-45J	220/50	Hi/Low	86/55	350/290	270/250	35/28	10.6/9.0	φ147
DPT20-55J	220/50	Hi/Low	130/97	650/500	365/300	42/38	12.7/10.8	φ197
DPT20-56J	220/50	Hi/Low	160/112	920/750	382/376	45/43	12.6/10.9	φ197

ULTRA-THIN SILENCE FAN



Energy Saving
Copper motor with high quality Ball bearing Low noise with stable air volume



Durable
High quality metal casing One piece casing Anticorrosion with power Spray



Flexible adjustment
For different applications Install with other type of fan to reach the best combination



Thin unit design
Optimal design, thin body Saving more space

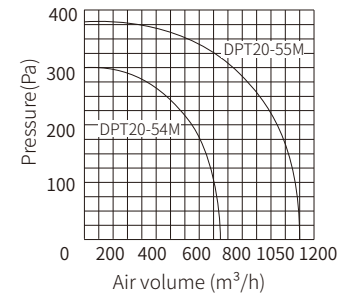
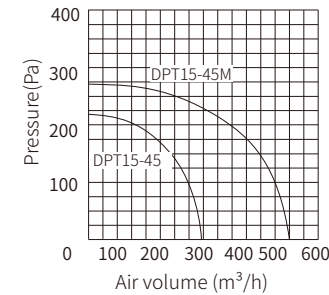
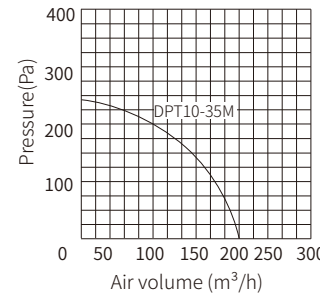

Model	Volt/Hz (V~/Hz)	Speed	Power (W)	Air volume (m³/h)	Pressure (Pa)	Noise (dB)	G.W/N.W (kg)	Diameter (φmm)
DPT10-35M	220/50	Hi/Low	52/30	230/180	160/150	25/24	7.4	φ95
DPT15-45	220/50	Hi/Low	73/45	350/250	220/200	30/25	8.3/6.7	φ147
DPT15-45M	220/50	Hi/Low	78/55	600/450	260/250	34/30	8.6/7.0	φ147
DPT20-54M	220/50	Hi/Low	110/75	920/700	365/355	38/34	9.5/7.5	φ197
DPT20-55M	220/50	Hi/Low	135/115	1200/1050	410/395	45/40	10.2/8.6	φ197

2(4) IN ONE VENTILATION FAN



Energy Saving

Copper motor with high quality Ball bearing
Low noise with stable air volume



Durable unit

With high quality metal
All one unit not easy to deform
Not prone to rust and corrosion
with powder spray



Flexible adjustment

For different applications
Install with other type of fan
to reach the best combination



Distance air supply

Optimization design
All parts are combine into perfect
With powerful air volume and stable
air pressure

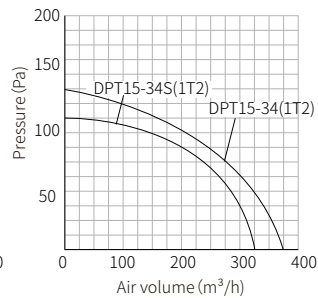
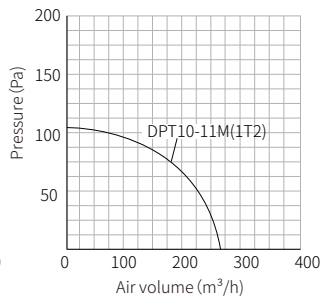
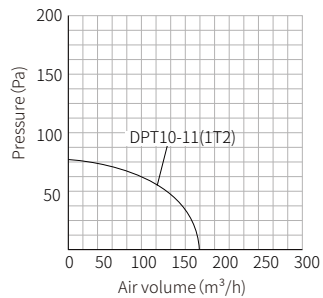

Model	Volt/Hz (V~/Hz)	Speed	Power (W)	Air volume (m³/h)	Pressure (Pa)	Noise (dB)	G.W/N.W (kg)	Diameter (φmm)
DPT10-11(1T2)	220/50	/	23	160	75	38	2.5/2.1	φ100
DPT10-11M(1T2)	220/50	/	30	250	250	43	2.6/2.3	φ100
DPT15-34S(1T2)	220/50	Hi/Low	33/28	300/210	110/100	41/38	3.6/3.1	φ150
DPT15-34(1T2)	220/50	Hi/Low	42/33	400/320	155/136	52/41	3.8/3.3	φ150

SILENT VENTILATION FAN



Energy Saving

Copper motor with high quality Ball bearing
Low noise with stable air volume



Durable unit

With high quality metal
All one unit not easy to deform,
not prone to rust and corrosion
with powder spray



Flexible adjustment

For different applications
Install with other type of fan
to reach the best combination



Distance air supply

Optimization design
All parts are combine into perfect
With powerful air volume and stable
air pressure

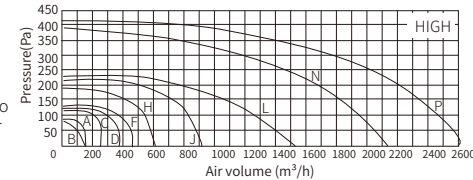
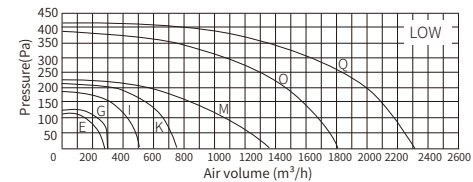

Model	Hi	Low
DPT10-11	A	/
DPT10-11S	B	/
DPT10-11M	C	/
DPT15-34S	D	E
DPT15-34	F	G
DPT15-34M	H	I
DPT20-45M	J	K
DPT20-65M	L	M
DPT20-75	N	O
DPT25-80	P	Q

Model	Volt/Hz (V~/Hz)	Speed	Power (W)	Air volume (m³/h)	Pressure (Pa)	Noise (dB)	G.W/N.W (kg)	Diameter (φmm)
DPT10-11	220/50	/	29	150	65	40	2.3/2.0	φ100
DPT10-11M	220/50	/	43	250	106	45	2.1/1.9	φ100
DPT15-34	220/50	Hi/Low	42/30	450/300	127/120	42/38	2.4/2.2	φ150
DPT15-34M	220/50	Hi/Low	85/65	600/500	170/150	46/42	4.6/4.1	φ150
DPT20-45M	220/50	Hi/Low	200/180	900/750	207/190	48/46	9.2/8.2	φ200
DPT20-65M	220/50	Hi/Low	230/215	1500/1350	220/202	52/50	11.2/10	φ200
DPT20-75	220/50	Hi/Low	280/230	2100/1800	380/290	56/52	11.3/10	φ200

AIR FILTER BOX



<p>Pre-filter</p> <p>Stop over 5µm dust particles, various pollutants such as pollen and hair can effectively improve air quality</p>	<p>Activated carbon filter</p> <p>high-quality granular activated carbon remove indoor odors and formaldehyde Keep indoor clean and fresh</p>	<p>HEPA filter</p> <p>high-density filter Stop dust, smoke and PM2.5 purification rate can reach 98%</p>
--	--	---





Model	Air volume (m³/h)	Pressure loss rate (%)	Size (mm)	Diameter (mm)	Primary filter	Activated carbon composite filter	High-efficiency filter
GLX-100	120-320	15-20%	300x200x200	100	G4 filtration grade	Odor elimination and sterilization	H13 filtration grade
GLX-150	220-550	15-20%	300x200x200	150	G4 filtration grade	Odor elimination and sterilization	H13 filtration grade
GLX-200	520-1500	15-20%	430x300x300	200	G4 filtration grade	Odor elimination and sterilization	H13 filtration grade
GLX-250	1200-2600	15-20%	430x300x300	250	G4 filtration grade	Odor elimination and sterilization	H13 filtration grade

Note: Maintain or replace the filters in time. Timely maintenance or replacement of filters, pre-filter G4 can be washed and maintained, activated carbon filter can be maintained in the sun, H13 service life of up to 9 months replacement.

TWO-WAY VENTILATION SERIES

Remark: All models with Switch. Other controller for optional.



- 
Energy Saving
 Copper motor with high quality Ball bearing
 Low noise with stable air volume
- 
Solid and durable
 Full metal body
 Integrally formed casing
 Not easy to be corroded and rusted
- 
Thin body
 Casing is as thin as 20cm
 Save more space
 Suitable for all area
- 
Independent air supply and exhaust
 Independent air supply
 With fresh air Independent exhaust
 Running the indoor air circulation

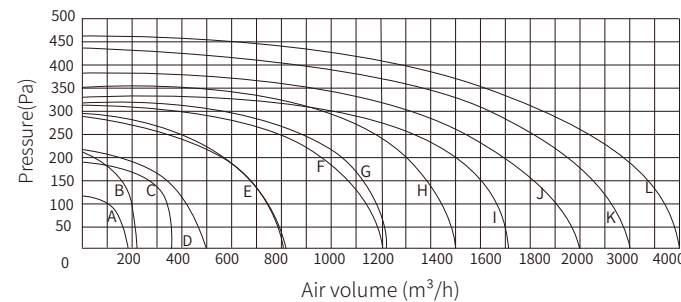

Model	Hi	Low
DUT10-34	B	A
DUT15-45	D	C
DUT20-60	F	E
DUT25-66	H	G
DUT25-76	J	I
DUT-3000M	K	/
DUT-4000M	L	/

Model	Volt/Hz (V~/Hz)	Speed	Power (W)	Air volume (m³/h)	Pressure (Pa)	Noise (dB)	G.W (kg)	Diameter (φmm)
DUT10-34	220/50	Hi/Low	80/50	230/180	210/110	36/32	16.2	φ95
DUT15-45	220/50	Hi/Low	160/120	500/350	210/190	38/35	19.0	φ147
DUT20-60	220/50	Hi/Low	450/400	1000/800	320/270	43/40	22.2	φ197
DUT25-66	220/50	Hi/Low	490/450	1500/1200	350/320	47/45	50.0	φ247
DUT25-76	220/50	Hi/Low	800/700	2000/1700	370/340	50/48	30.0	φ247
DUT-3000M	220/380/50	/	1100	3000	440	53	68.0	280x280
DUT-4000M	220/380/50	/	1500	4000	460	53	72.0	350x280

DIRECT DUCT FAN

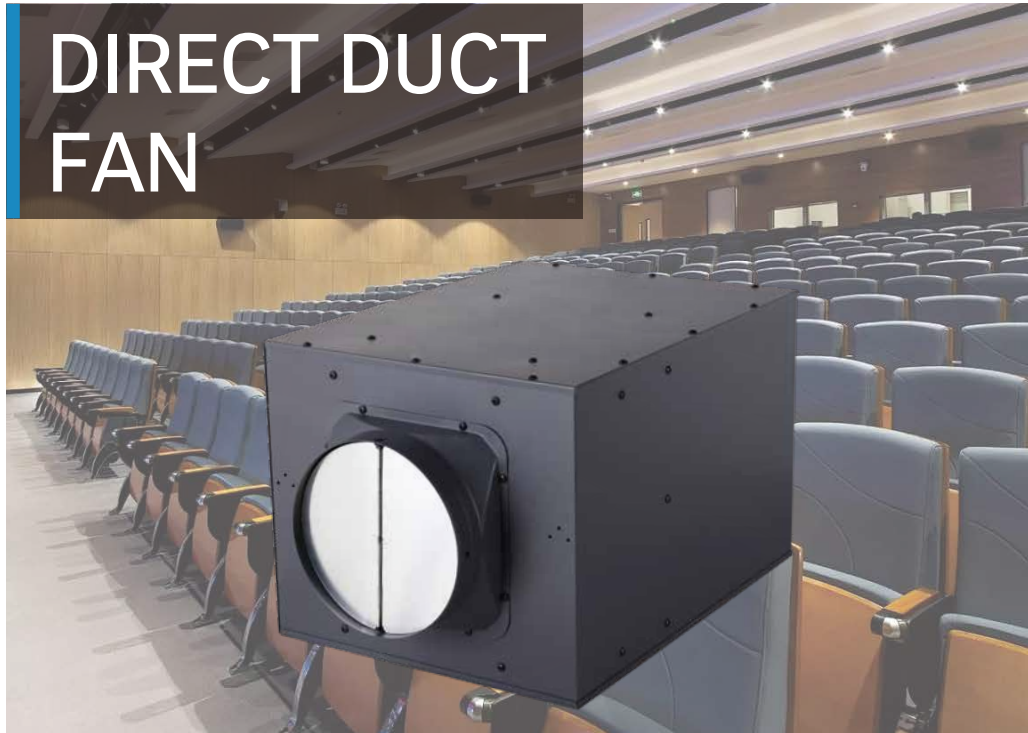

- Energy Saving**
Copper motor with high quality Ball bearing
Low noise with stable air volume
- Durable**
High quality metal casing One piece casing Anticorrosion with power Spray
- Flexible adjustment**
For different applications Install with other type of fan to reach the best combination
- Distance air supply**
Optimization design All parts are combine into perfect With powerful air volume and stable air pressure

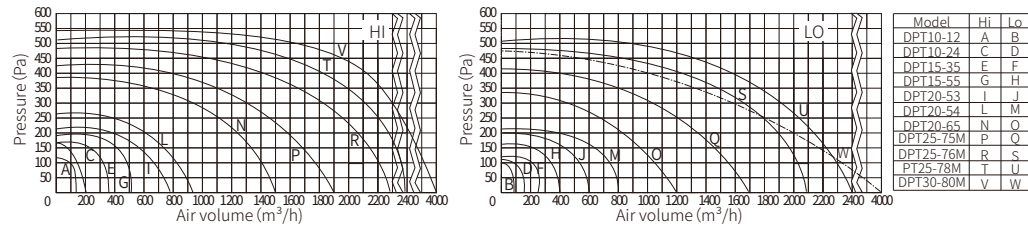

Model	Volt/Hz (V-/Hz)	Speed	Power (W)	Air volume (m³/h)	Pressure (Pa)	Noise (dB)	G.W/N.W (kg)	Diameter (φmm)
DPT10-12	220/50	Hi/Low	22/21	120/80	120/100	20/18	6.7/5.7	φ95
DPT10-24	220/50	Hi/Low	30/24	200/150	160/110	23/20	6.9/5.9	φ95
DPT15-35	220/50	Hi/Low	68/62	360/250	160/120	27/23	9.3/8.1	φ147
DPT15-55	220/50	Hi/Low	90/78	500/400	190/165	29/27	9.3/8.1	φ147
DPT20-53	220/50	Hi/Low	116/104	770/600	210/220	35/29	10.7/9.3	φ197
DPT20-54	220/50	Hi/Low	184/161	920/800	260/220	37/35	12.3/10.7	φ197
DPT20-65	220/50	Hi/Low	299/285	1500/1200	380/340	43/39	19/16.8	φ197
DPT25-75M	220/50	Hi/Low	403/311	1900/1700	430/420	45/43	24/21.6	φ247
DPT25-76M	220/50	Hi/Low	460/391	2300/2100	490/480	46/45	24.3/22	φ247
DPT25-78M	220/50	Hi/Low	598/506	2600/2400	530/510	47/45	35/22.6	φ247
DPT30-80M	220/50	Hi/Low	644/518	4000/3200	550/470	49/47	31.8/28.2	φ247

ROOF FAN



- Feature**
- Excellent air follows compared to other products.
- Minimize the exhausting resistance and optimum design to preventan adverse air follows.
- Easy to install, Excellent durability.

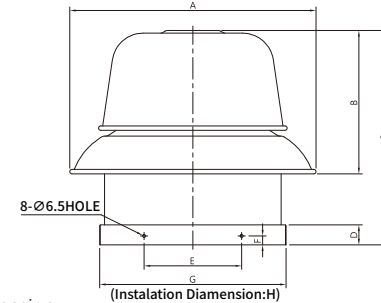

Dimension	(mm)							
Model	A	B	C	D	E	F	G	H
DVR-200	Ø555	323	408	45	220	20	420	408
DVR-260	Ø555	323	433	45	220	20	420	408
DVR-320	Ø555	323	483	45	220	20	420	408

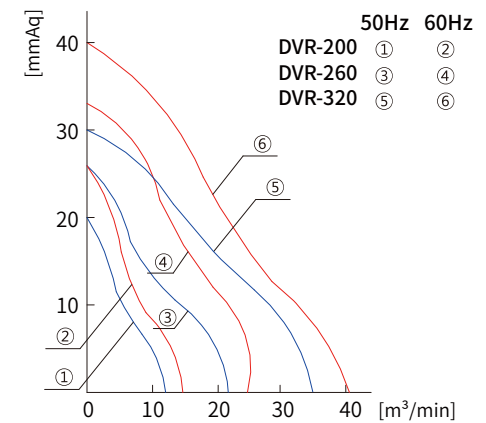

Model	Source (V)	Blade Size (cm)	Fre- quency (Hz)	Currecnt (A)	Power Input (W)	Revolution per minute (RPM)	Motor Output (KW)	Pole (P)	Air Volume (CMM) (CFM)	Air Pressure (mmAq) (pa)	Weight (kg)	
DVR-200	1 Ø220V	25	50	0.50	74	1475	0.06	4	12	423	20	196
			60	0.45	82	1765			14.5	512	26	255
DVR-260	1 Ø220V	26	50	0.60	105	1440	0.08	4	21	705	26	255
			60	0.65	140	1700			24	795	34	335
DVR-320	1 Ø220V	32	50	1.20	200	1440	0.25	4	34	1200	30	295
			60	1.30	290	1690			40	1410	40	390

CIRCULAR DUCT FAN



Energy Saving

Copper motor with high quality Ball bearing
Low noise with stable air volume



Durable

High quality metal casing
One piece casing
Anti-corrosion with power Spray



Flexible adjustment

For different applications
Install with other type of fan to reach the best combination



Distance air supply

Optimization design All parts are combine into perfect
With powerful air volume and stable air pressure

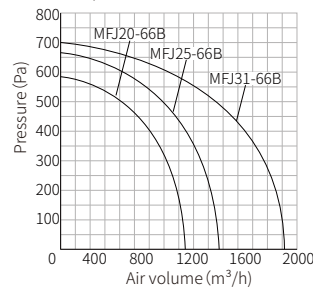
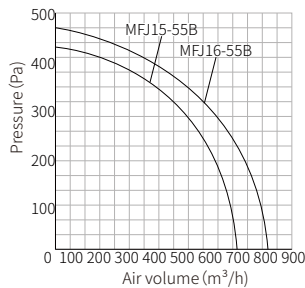
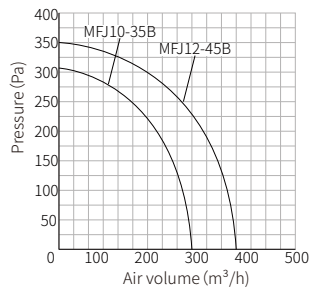

Model	Volt/Hz (V~/Hz)	Power (W)	Air volume (m³/h)	Pressure (Pa)	Noise (dB)	G.W/N.W (kg)	Diameter (φmm)
MFJ10-35B	220/50	85	310	315	52	3.8/3.1	φ100
MFJ12-45B	220/50	85	385	350	50	3.8/3	φ125
MFJ15-55B	220/50	105	720	443	53	5.6/4.3	φ150
MFJ16-55B	220/50	126	850	470	55	5.4/4.2	φ160
MFJ20-66B	220/50	160	1120	580	60	6.0/4.8	φ200
MFJ25-66B	220/50	182	1320	570	62	6.0/4.8	φ250
MFJ31-66B	220/50	260	1900	700	65	7.6/6.1	φ315

MIXED FLOW FAN



MF-100P/150P/200P/250P/315P



Energy Saving

Copper motor with high quality Ball bearing
Low noise with stable air volume



Flexible adjustment

For different applications
Install with other type of fan to reach the best combination



Durable

High quality ABS material
Strong and compressive, not easy to deform and sink



Easy install Maintain design

Compact and small casing
Simple structure for easy install

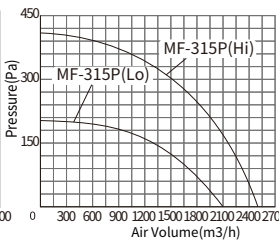
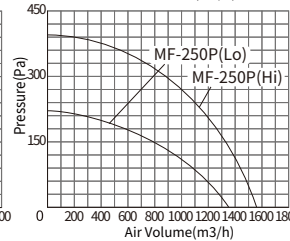
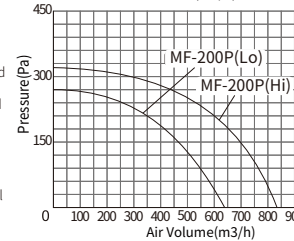
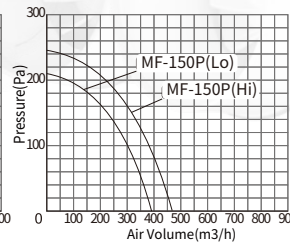
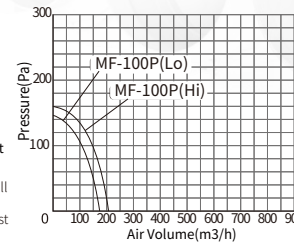

Model	Hi	LOW
MF-100P	A	a
MF-150P	B	b
MF-200P	C	c
MF-250P	D	d
MF-315P	E	e

Model	Volt/Hz (V~/Hz)	Speed	Power (W)	Air volume (m³/h)	Pressure (Pa)	Noise (dB)	G.W/N.W (kg)
MF-100P	220/50	Hi/Low	35/30	204/160	132/106	31/26	2.0/1.6
MF-150P	220/50	Hi/Low	75/65	450/360	280/240	33/29	2.5/1.9
MF-200P	220/50	Hi/Low	140/125	840/690	350/270	63/55	3.2/2.6
MF-250P	220/50	Hi/Low	220/200	1400/1050	489/370	66/58	6.6/5.3
MF-315P	220/50	Hi/Low	420/350	2200/1750	690/430	69/61	11.0/9.4

EC INLINE DUCT FAN



Each fan uses a quiet, energy-efficient EC motor controlled using Pulse Width Modulation (PWM).



Featuring a mixed flow design, ingress-protected against dust and liquids.



Precise speed controller with ten speeds and temperature & humidity monitoring

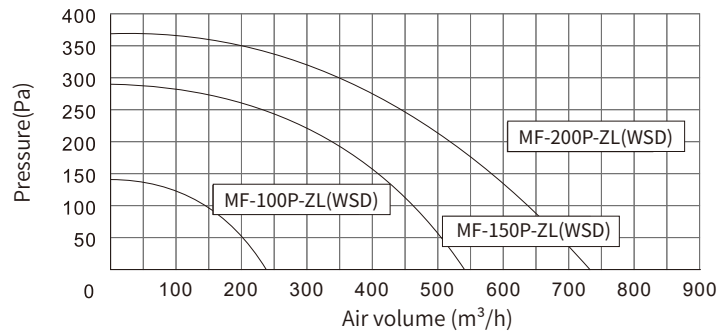

Model	Volt/Hz (V~/Hz)	Frequency (Hz)	Power (W)	Air volume (m³/h)	Pressure (Pa)	Noise (dB)	G.W (kg)
MF-100P-ZL(WSD)	110~240	50/60	37	240	142	32	2.0
MF-150P-ZL(WSD)	110~240	50/60	50	540	295	36	2.4
MF-200P-ZL(WSD)	110~240	50/60	90	850	360	48	3.8

BOOSTER FAN



Superior balanced blades for long service life & quiet operation.



Motor features a permanently lubricated bearing that operates quietly and requires no maintenance



Precise speed controller with ten speeds and temperature & humidity monitoring



Max Operating Temp of Motor is 130°C/266°F; Max Ambient Temp is 60°C/140°F

Model	Volt/Hz	Current	Power	Noise	Speed	Air volume	N.W
MF-100ZT	110V/60Hz or 220-240V/50Hz	0.15Amps	15W	28dB	2960RPM	100CFM	0.6KG
MF-150ZT	110V/60Hz or 220-240V/50Hz	0.68Amps	37W	35dB	2930RPM	240CFM	1.2KG
MF-200ZT	110V/60Hz or 220-240V/50Hz	0.8Amps	42W	43dB	2900RPM	420CFM	1.3KG

AXIAL EXHAUST FAN



Energy Saving

100% copper wire motor for good conductivity.



Durable

Double ball bearing and fully sealed motor for long lifespan.



Humanized design

Special angel blades with high speed motor for large air volume.



Easy maintenance

Flexible front net cover design, easy remove for cleaning.

Size	Dimensions (mm)	Volt/Freq	Power (W)	Air Volume (m ³ /h)	RPM (r/min)	Diameter (mm)	Inner diameter (mm)	Outer diameter (mm)	Unit Size (mm)	Carton Size (mm)
12"	300	220V-50Hz	200	2400	1400	250	300	350	370*207*500	400*310*570
14"	350	220V-50Hz	290	3600	1400	250	350	400	430*300*540	450*300*595
16"	400	220V-50Hz	460	5500	1400	260	400	460	490*390*508	510*300*615
20"	500	220V-50Hz	690	8500	1400	260	500	550	580*400*680	590*300*670
24"	600	220V-50Hz	800	12500	1400	260	600	660	700*430*820	710*380*795

HIGH SPEED AXIAL FAN



Energy Saving

Low noise, large air flow, high efficiency, and stable air pressure.



Long-lasting Color

The fan is powder coated with lasting bright color.



Humanized design

The fan adopts specially designed forward curved three-dimensional twisted stainless steel blade.



Easy maintenance

Suitable for ventilation and cooling in workshops, warehouses public places and more.

Size	Volt/Freq	Power	RPM	Air Volume	Cylinder Inner Diameter	Cylinder Outer Diameter	Cylinder Height
10" High Speed	220V-50Hz	0.25kw	2800r/min	3000m ³ /h	264mm	314mm	230mm
12" High Speed	220V-50Hz	0.37kw	2800r/min	4500m ³ /h	315mm	365mm	240mm
12" Middle Speed	220V-50Hz	0.18kw	1450r/min	2450m ³ /h	315mm	365mm	240mm
14" High Speed	220V-50Hz	0.75kw	2800r/min	7500m ³ /h	360mm	410mm	290mm
14" Middle Speed	220V-50Hz	0.25kw	1450r/min	4000m ³ /h	360mm	410mm	290mm
16" High Speed	220V-50Hz	1.1kw	2800r/min	8500m ³ /h	417mm	467mm	330mm
16" Middle Speed	220V-50Hz	0.55kw	1450r/min	5600m ³ /h	417mm	467mm	330mm

PLASTIC EXHAUST CEILING MOUNTED FAN SERIES



Energy saving
Copper motor with high quality Ball bearing
Low noise with stable air volume



Durable
High quality ABS
Never rust
Strong and not easy to morph



Flexible adjustment
For all applications use



Easy maintenance
Thin body design
Ceiling mounted
Simple instruction

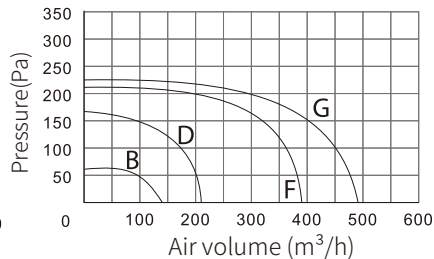
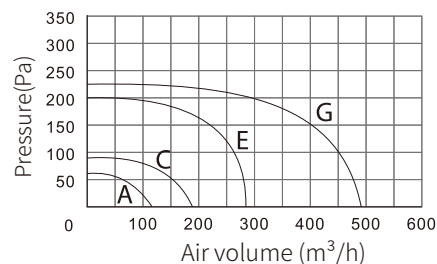

Model	
BPT10-12S	A
BPT10-15S	B
BPT10-17S	C
BPT10-21S	D
BPT10-30S	E
BPT15-40S	F
BPT15-50S	G

Model	Voltage (V~)	Frequency (Hz)	Power (W)	Air volume (m³/h)	Pressure (Pa)	Noise (dB)	G.W/N.W (kg)	PACK (Pcs)
BPT10-12S	220	50	24	120	65	42	1.6/1.3	6
BPT10-15S	220	50	25	144	65	42	1.5/1.3	6
BPT10-17S	220	50	30	180	95	41	1.9/1.6	6
BPT10-21S	220	50	34	210	165	43	2.4/2.1	6
BPT10-30S	220	50	40	276	200	45	2.3/2.0	6
BPT15-40S	220	50	45	390	205	46	3.0/2.6	6
BPT15-50S	220	50	51	480	210	47	2.6/2.2	6

INTEGRATED EXHAUST CEILING MOUNTED FAN SERIES

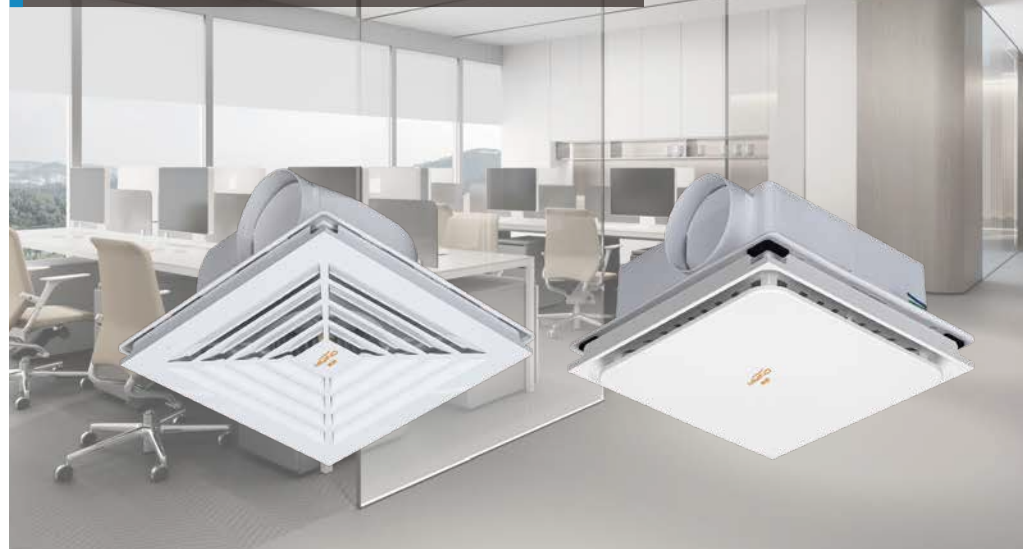

Energy saving
Copper motor with high quality Ball bearing
Low noise with stable air volume



Durable
With high quality aluminum
Compressive resistance
Never rust



Flexible adjustment
For all applications use



Easy maintenance
Thin body design
Ceiling mounted
Simple instruction

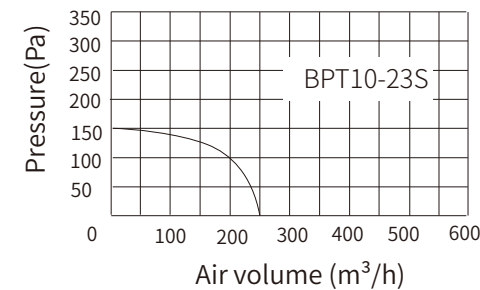
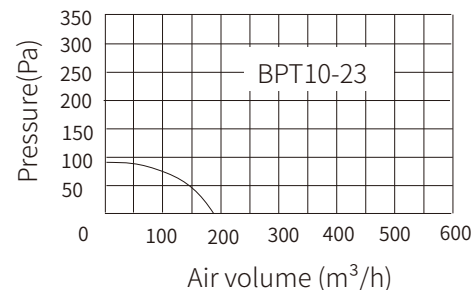

Model	Volt/Hz (V~/Hz)	Power (W)	Air volume (m³/h)	Pressure (Pa)	Install hole (mm)	Panel size (mm)	Duct size (Ømm)	Noise (dB)	G.W/N.W (kg)
BPT10-23	220-50	30	180	98	300x300	300x300	Ø100	42	1.6/1.4
BPT10-23S	220-50	30	250	150	300x300	300x300	Ø100	41	2.2/1.8

WALL-MOUNTED EXHAUST FAN SERIES



Energy Saving

Copper motor with high quality Ball bearing
Low noise with stable air volume



Humanized design

Automatic shut off the louver check when power off prevent backflow, prevent insects and rain



Durable

High quality ABS
Never rust Strong and not easy to morph



Easy maintenance

Thin body design
Wall mounted
Simple instructure

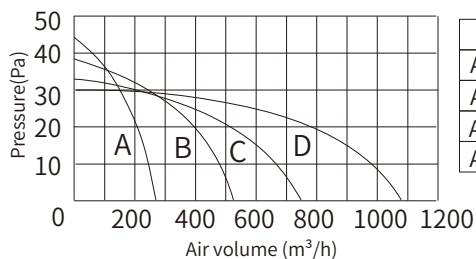

Model	
APB15-3-B	A
APB20-4-B	B
APB25-5-B	C
APB30-6-B	D

Model	Volt/Hz (V~/Hz)	Power (W)	Air volume (m³/h)	Install hole size (mm)	Noise (dB)	G.W/N.W (KG)
APB15-3-A	220-50	25	270	198x198	36	1.2
APB15-3-B	220-50	25	270	198x198	36	1.5/1.3
APB20-4-A	220-50	30	500	248x248	40	1.9
APB20-4-B	220-50	30	500	248x248	40	2.0/1.7
APB25-5-A	220-50	40	750	298x298	43	2.4
APB25-5-B	220-50	40	750	298x298	43	2.2/1.9
APB30-6-A	220-50	45	1100	348x348	45	2.9
APB30-6-B	220-50	45	1100	348x348	45	3.1/2.7

Remark : Model-A is without grille. Model-B is with grille.

CENTRIFUGAL FAN SERIES



Energy Saving

Copper motor with high quality Ball bearing
Low noise with stable air volume



Durable

High quality metal casing
One piece casing
Anti-corrosion with power Spray



Flexible adjustment

For different applications
Install with other type of fan to reach the best combination



Distance air supply

Optimization design
All parts are combine into perfect
With powerful air volume and stable air pressure

Model	Voltage (v)	Frequency (Hz)	Current (A)	Input Power (W)	Speed (RPM)	Max Air Flow (m³/h)	Pressure (Pa)	Capacitor (uF)	Noise (dB)
MFJDF103561	220V	50/60	0.279/0.315	61/69	2233/2432	310	315	2uF/450V	52
MFJDF155587	220V	50/60	0.398/0.495	87/108	2321/2435	720	443	3uF/450V	53
MFJDF2066119	220V	50/60	0.547/0.643	119/140	2220/2329	1120	580	4uF/450V	60
MFJDF2566129	220V	50/60	0.589/0.681	129/150	2112/2127	1320	570	4uF/450V	62
MFJDF3119366	220V	50/60	0.891/1.016	193/221	2062/1896	1900	700	6uF/450V	65

CENTRIFUGAL AIR CONDITIONING FAN



Energy Saving
Copper motor with high quality Ball bearing Low noise with stable air volume



Static Pressure
Optimize motor and air duct
Static pressure



Flexible adjustment
Different application
Air volume from 2000 to 25000 m³/h



Easy maintenance
Maintain design
Easy for checking motor and replace filter

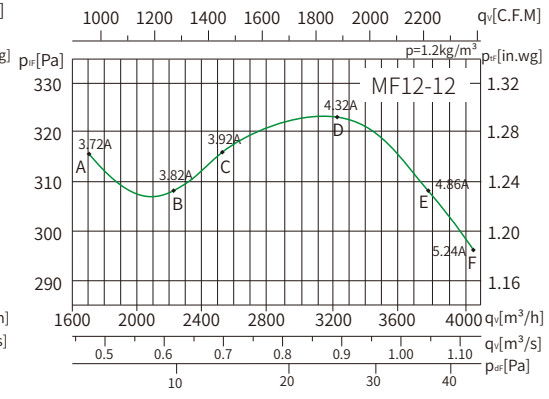
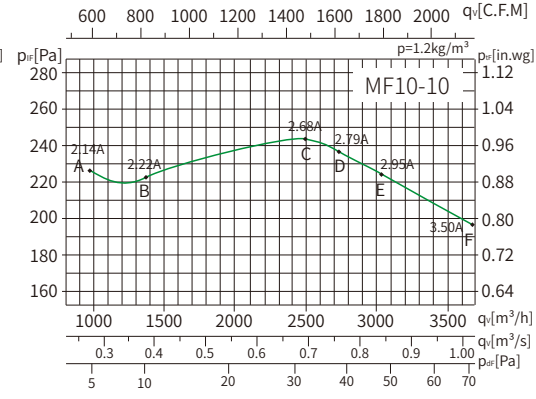
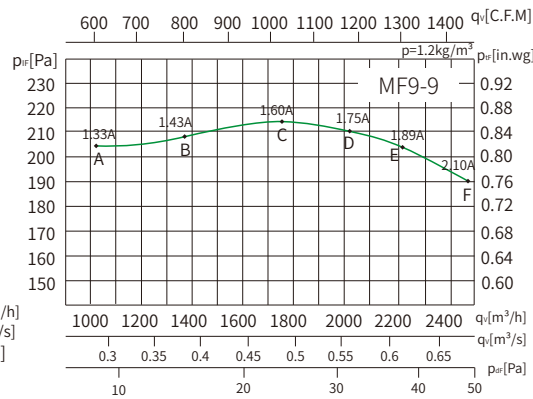
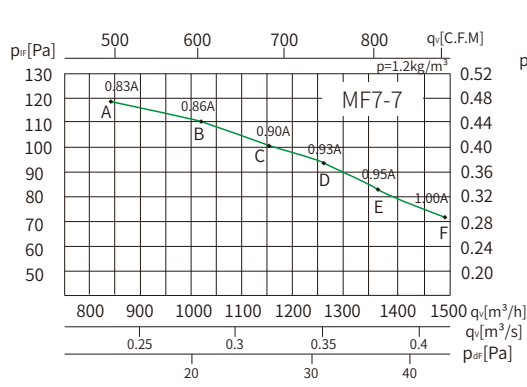

Model	Voltage (V~)	Frequency (Hz)	Input power (W)	Current (A)	Speed (Rpm)	Noise (dB)	N.W (kg)	IP Rate
MF7-7	220	50	90	1.1	934	63.4	8.85	20
MF9-9	220	50	250	2.1	959	67.5	14.1	20
MF10-10	220	50	450	3.5	975	72.5	18.3	20
MF12-12	220	50	750	5.4	955	81.0	24.4	20

CASING WITH BLOWER



Energy Saving

Copper motor with high quality Ball bearing
Low noise with stable air volume



Static Pressure

Optimize motor and air duct Static pressure



Flexible adjustment

Different application
Air volume from 2000 to 25000 m3/h



Easy maintenance

Maintain design
Easy for checking motor and replace filter

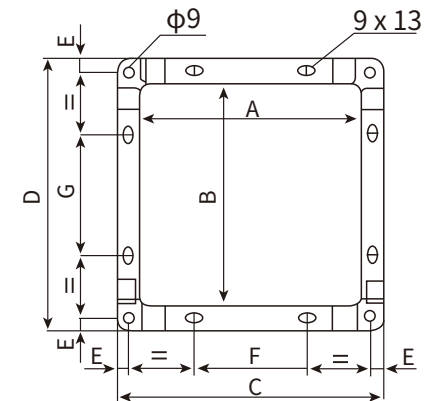
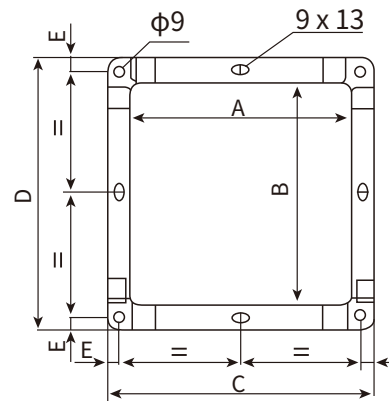

Model	Dim	A	B	C	D	E	F	G
7-7		259	228	299	268	10	-	-
9-9		298	262	338	302	10	-	-
10-10		331	289	387	345	13	-	-
12-12		395	341	451	397	13	150	140
15-15		471	404	527	460	13	180	160
18-18		557	478	613	534	13	200	180



FOSHAN MIFENG ELECTRICAL EQUIPMENT CO.,LTD

E-mail: miwind@miwinds.com

Website: www.miwindair.com

Add:No.17bis ,613 Road ,Nansha Industrial Zone,Nansha Community
Danzao Town ,Nanhai District, Foshan City ,Guangdong,China.